

PRODUTTORI DI IMPIANTI AVICOLI
Productores de **POULTRY EQUIPMENT**
Equipos Avícolas **MANUFACTURERS**
PRODUCTEURS D'ÉQUIPEMENTS
Производители **AVICOLES**
оборудования для птицеводства
مصنعي معدات الدواجن
鸡禽饲养设备
PRODUTORES 가금류 장비 제조업체
DE INSTALAÇÕES AVICULAS KÜMES
養鶏設備メーカー HAYVANLARI
EKİPMANI ÜRETİCİLERİ
ผู้ผลิตอุปกรณ์สำหรับการผลิตสัตว์ปีก



MADE IN ITALY

MODULO M - MEU XL Series

LAYING CAGE SYSTEM

Belt clean multi-tier system from 3 up to 12 tiers

www.valli-italy.com

info@valli-italy.com

+39.0543.975311



YouTube



WEB



in

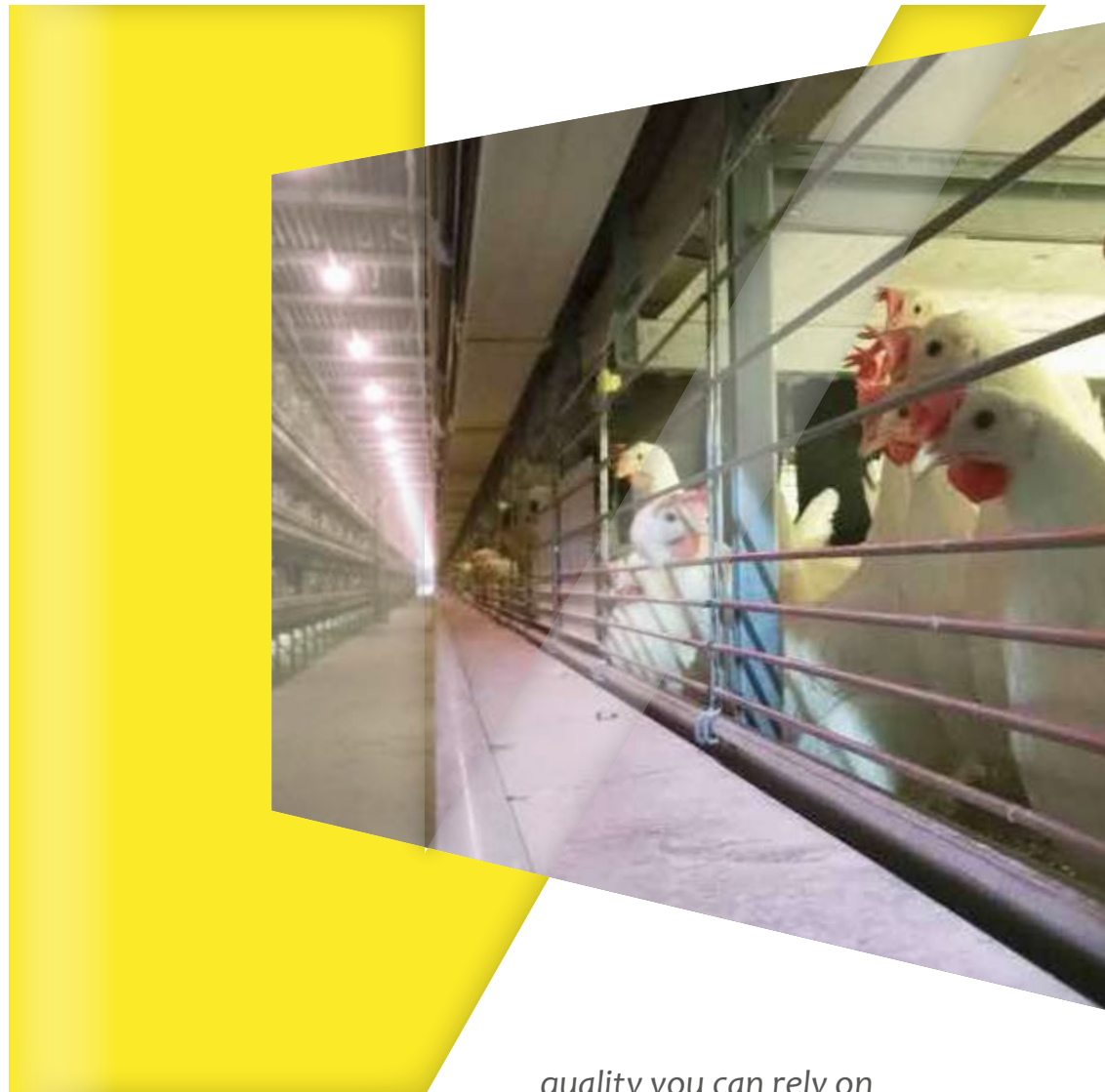

quality you can rely on

... WELL PLANNED FOR A LONG LIFE

VALLI S.r.l.
Via Selva,14 - 47122 Forlì FC - ITALY

Modulo - MEU XL - DE96671 - 20241015_S5

EN





MODULO M - MEU XL

LAYING CAGE SYSTEM

With or without ENRICHMENT

Belt clean multi-tier system from 3 up to 12 tiers

Models	M - MEU XL	186	223	233
Overall width (rail/rail)	mm	2340	2710	2810
Length of modular section	mm	2900 (support frame every 1450mm)		
Floor slope	mm	6.5°	6.5°	6.5°
Height tier to tier	mm	725	725	725

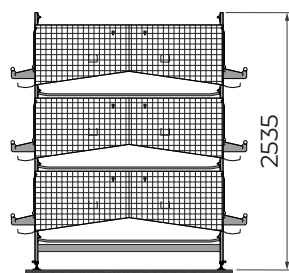

3 tiers

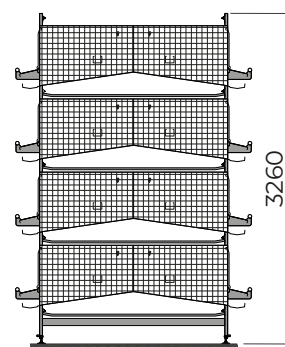

4 tiers

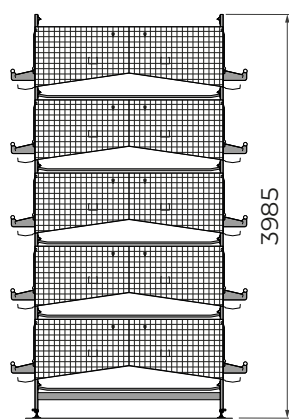

5 tiers

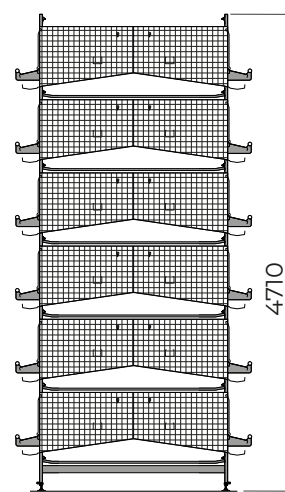

6 tiers

Heights are subject to decrease due to feet adjustment

Valli should reserve the right to freely change models and technical specifications at any time without prior notice

MODULO M - MEU XL

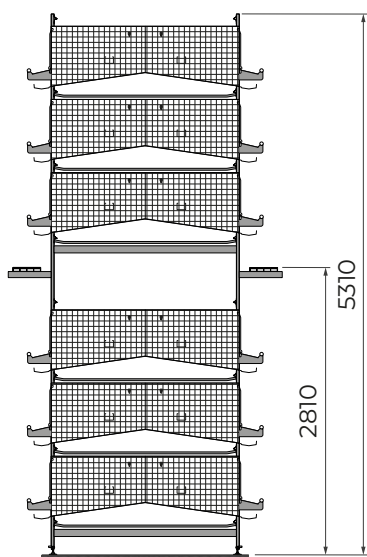

6 tiers DD

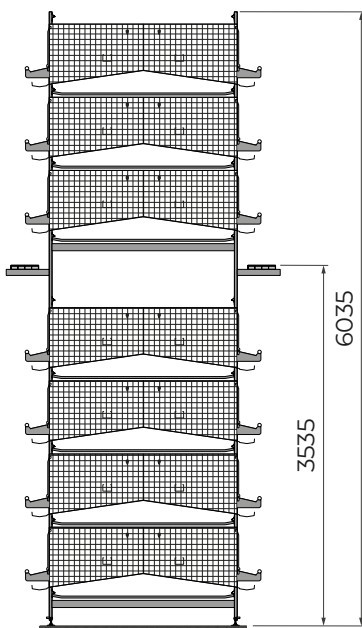

7 tiers DD

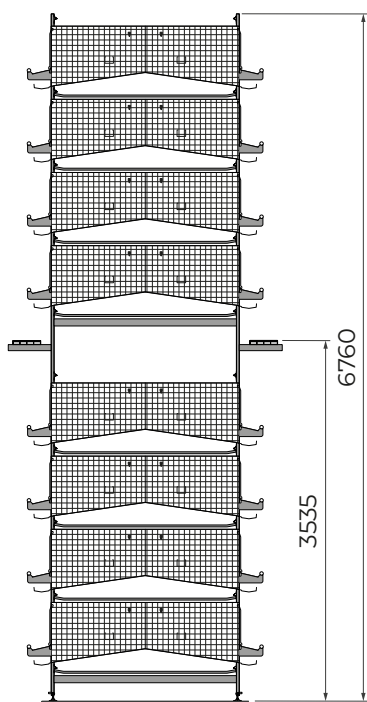

8 tiers DD

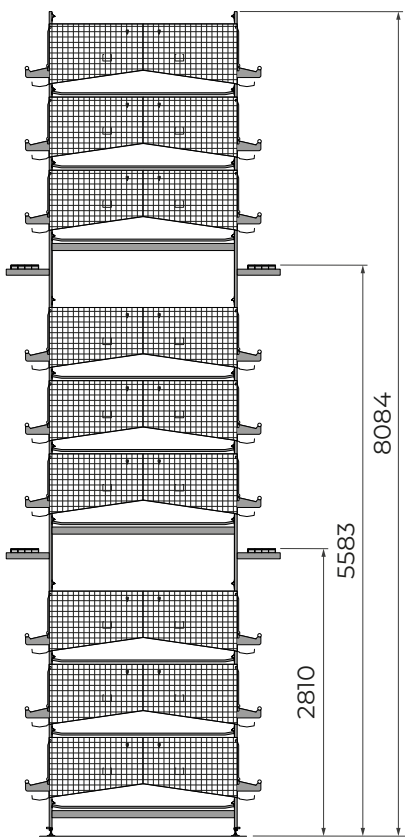

9 tiers TD

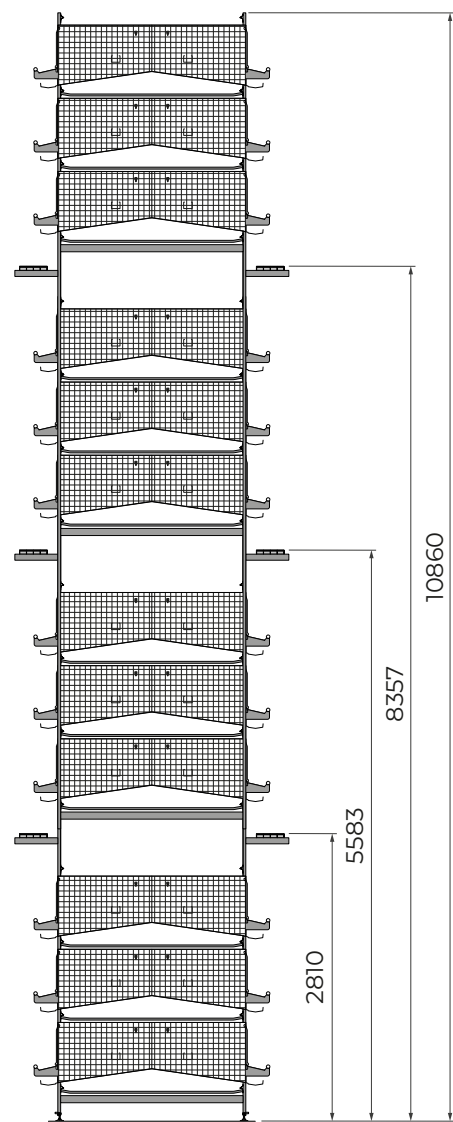

12 tiers QD

Heights are subject to decrease due to feet adjustment

Valli should reserve the right to freely change models and technical specifications at any time without prior notice

D8 CAGE PARTITION

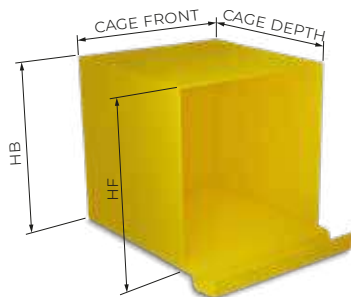

Models	M XL	186	223	233
Cage depth	mm	930	1115	1165
Cage front	mm	725	725	725
Cage floor surface	cm ²	6742	8083	8446
HB (Height at the back)	mm	460	460	460
HF (height at the front)	mm	590	590	590

D4 CAGE PARTITIONS

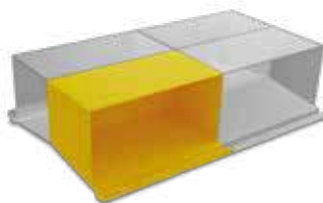
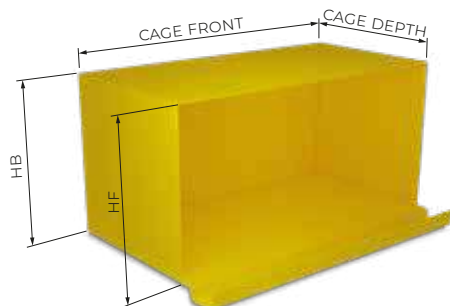

Models	M XL	186	223	233
Cage depth	mm	930	1115	1165
Cage front	mm	1450	1450	1450
Cage floor surface	cm ²	13485	16167	16892
HB (Height at the back)	mm	460	460	460
HF (height at the front)	mm	590	590	590

D2 ENRICHED COLONY

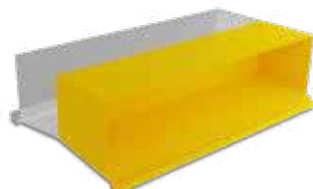
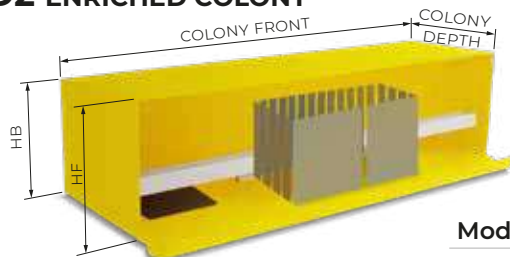

Models	MEU XL	186	223	233
Colony depth ENRICHED	mm	930	1115	1165
Colony front ENRICHED	mm	2900	2900	2900
Colony floor surface ENRICHED	cm ²	26970	32335	33785
HB (Height at Back)	mm	460	460	460
HF (Height at Front)	mm	590	590	590

Heights are subject to decrease due to feet adjustment

Valli should reserve the right to freely change models and technical specifications at any time without prior notice



Care — Durability — Flexibility — Reliability — Service

MODULO MEU XL - ENRICHED

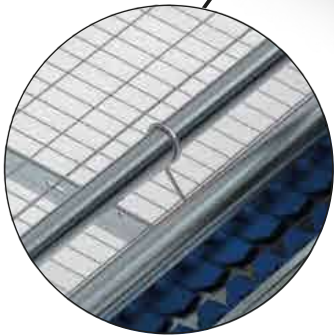
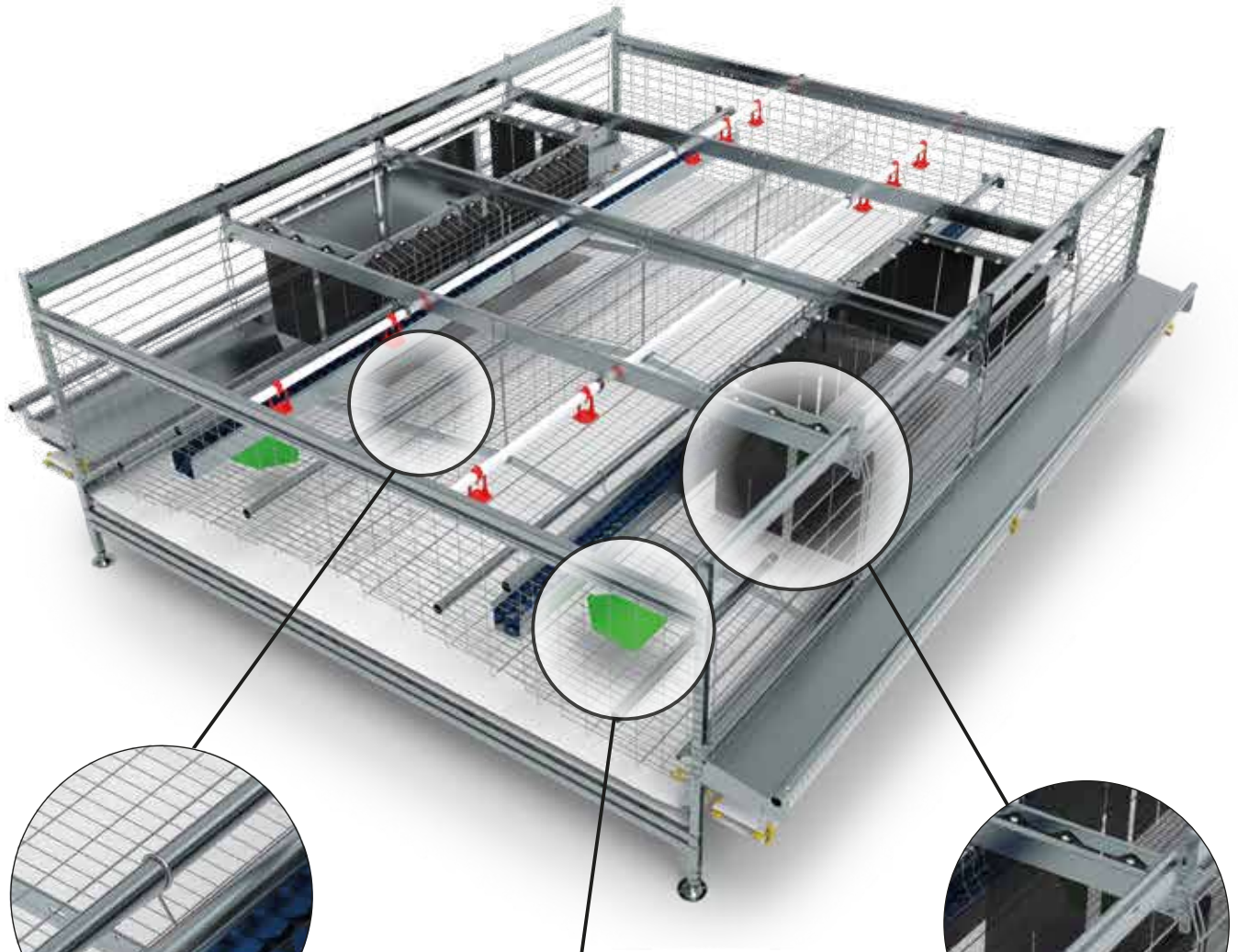

Perches

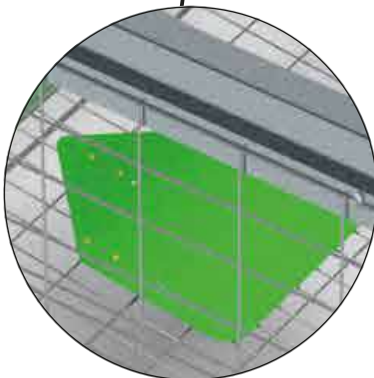
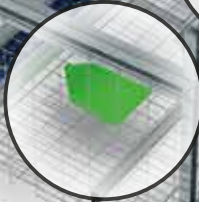

Scratch mats



Nest



EXCELLENCE IN POULTRY EQUIPMENT

VALLI S.r.l.
Via Selva,14 - 47122 Forlì FC - ITALY
www.valli-italy.com info@valli-italy.com

- Overall dimension for optimized density
- Internal colony feed trough
- Easy and quick installation
- Essential design reducing gaps for red mites
- Available in multi-tier configuration with intermediate catwalks
- Flat chain feeding system
- Improved manure cleaning drive for easy maintenance
- Available with or without “PVC” duct for manure drying

